

sew

Issue 97 May issue 2017

**PRINT
OUT
& KEEP**

LIZZIE TUNIC TEMPLATES

Use these guides to get started today

JUST PRINT OUT THE PAGE OR PAGES YOU
NEED FROM YOUR PRINT MENU

In your print menu, under Size options, be sure to
select to print 'Actual Size', instead of 'Fit to Page'

Title: Lizzie Tunic
Designer: Julia Claridge
Magazine page: 18
Total 22 pages to print

© ACEVILLE PUBLICATIONS LTD | WWW.SEWMAG.CO.UK

All projects, templates and patterns are for personal home use only and cannot be sold or used for commercial purposes.

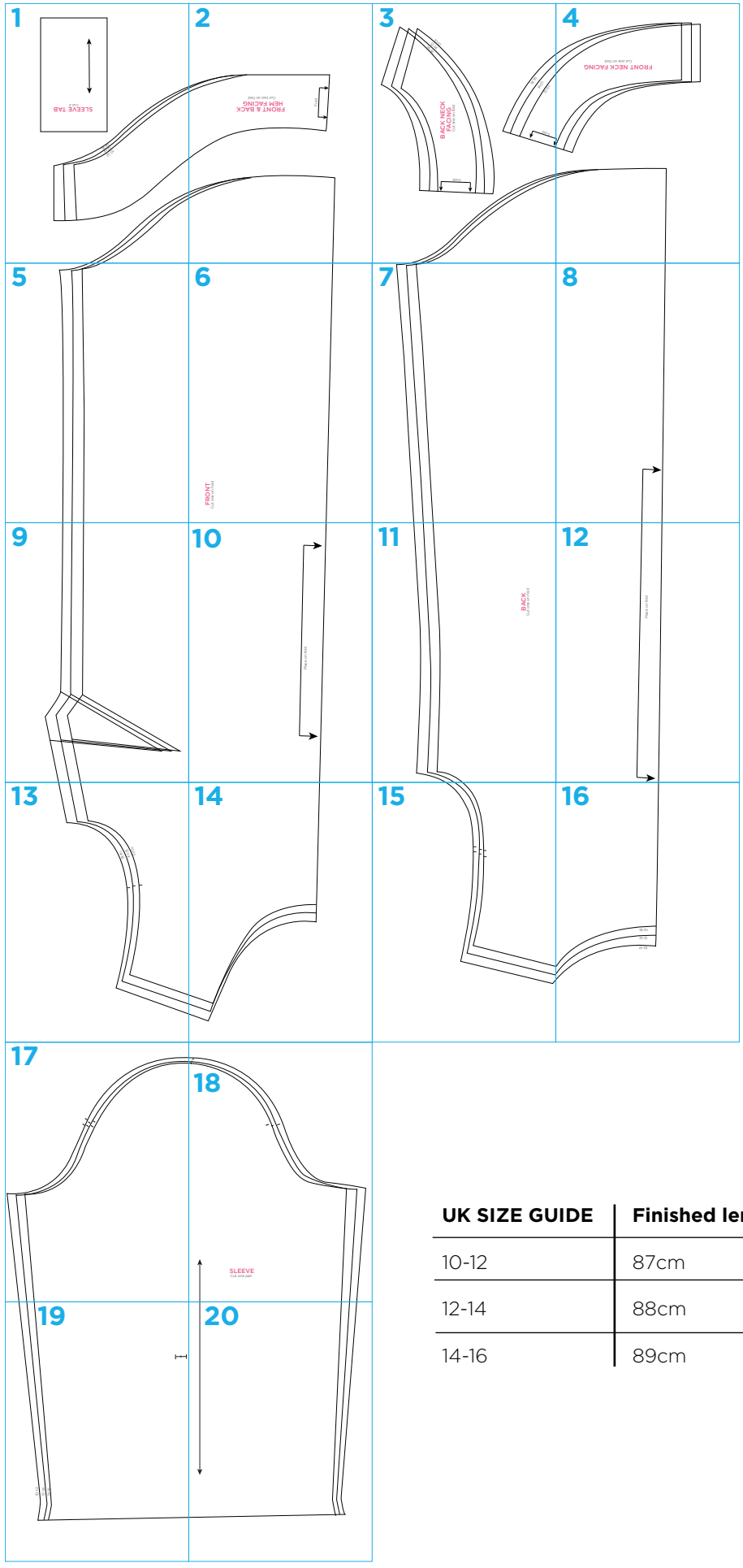

UK SIZE GUIDE	Finished length	Chest
10-12	87cm	101cm
12-14	88cm	106cm
14-16	89cm	111cm

1

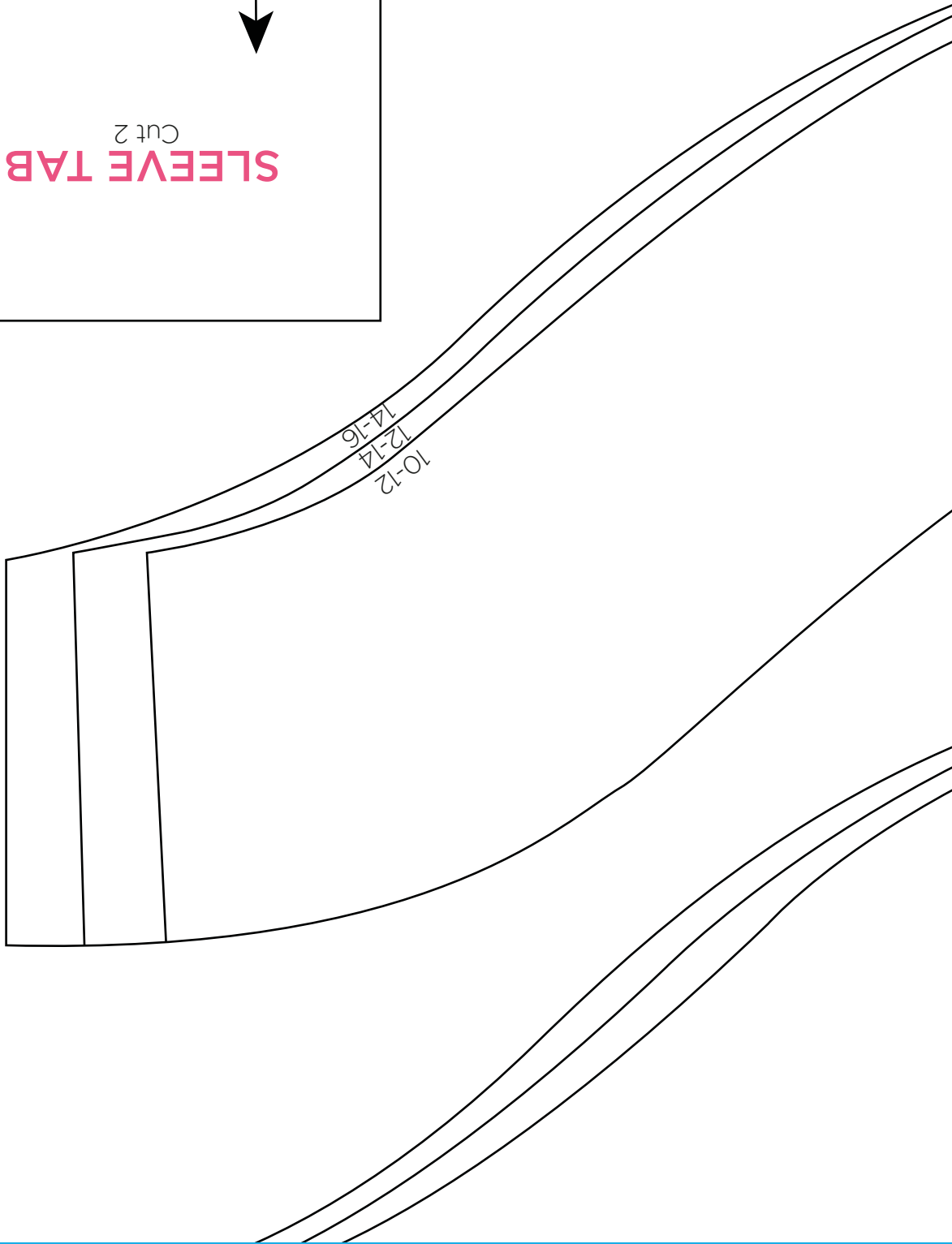
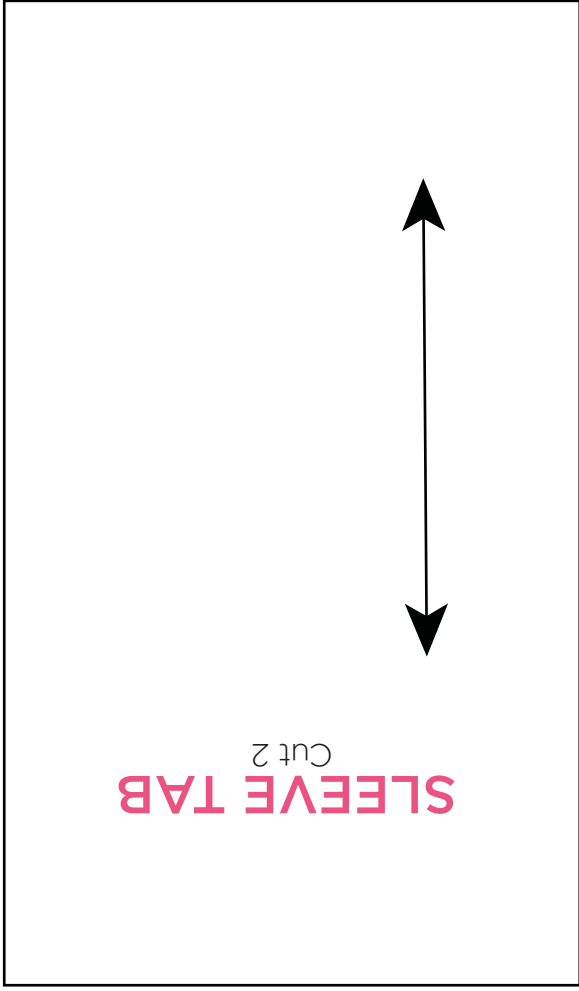

2

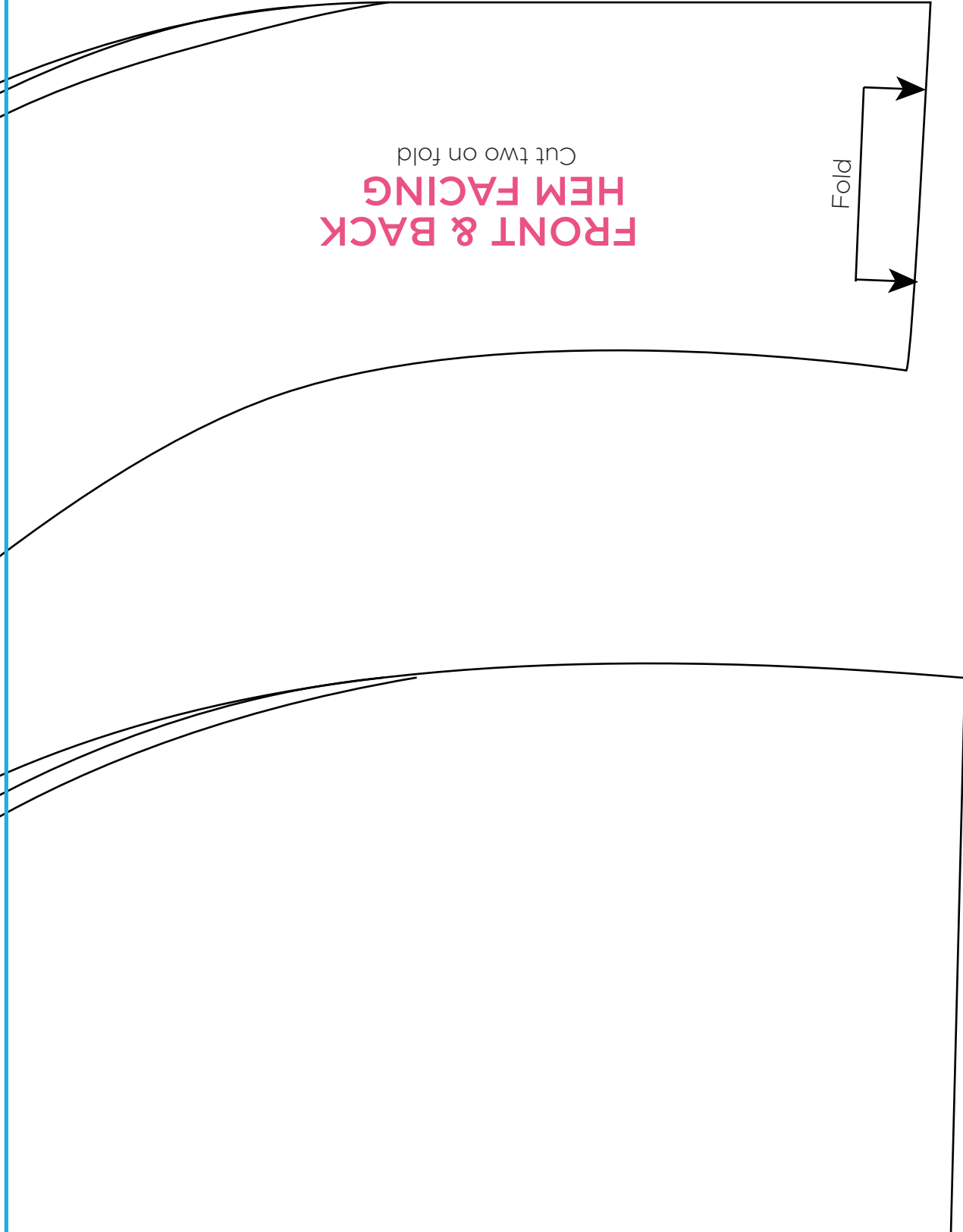

3

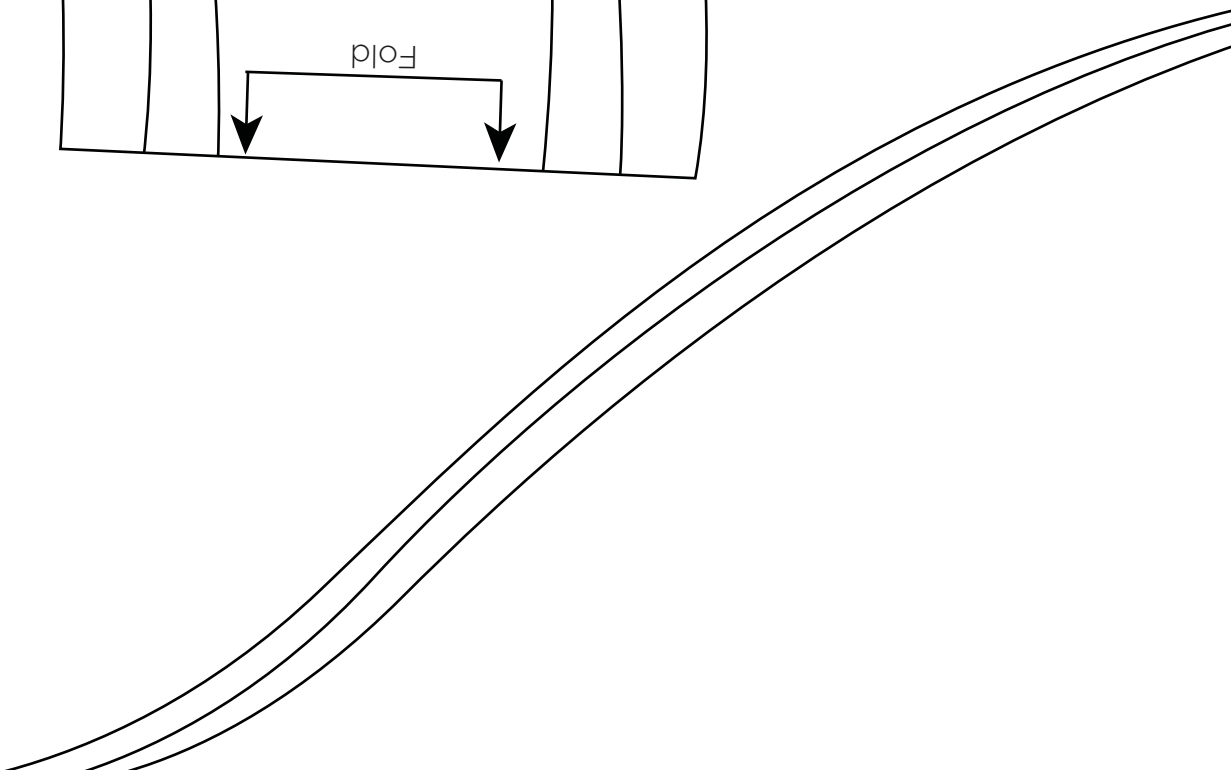
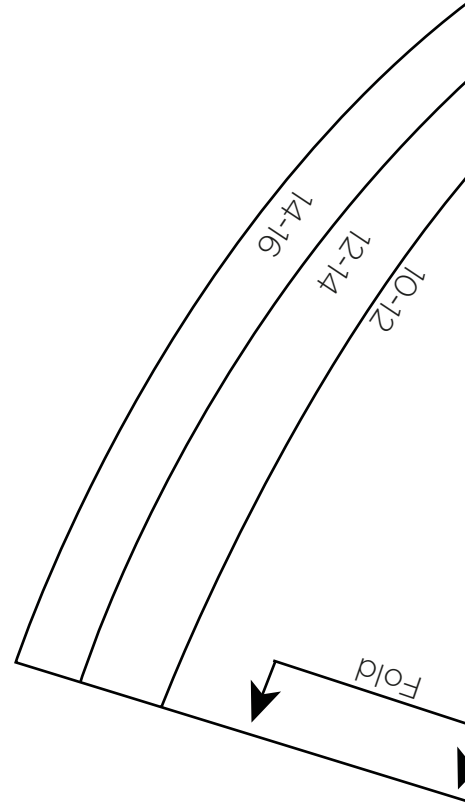
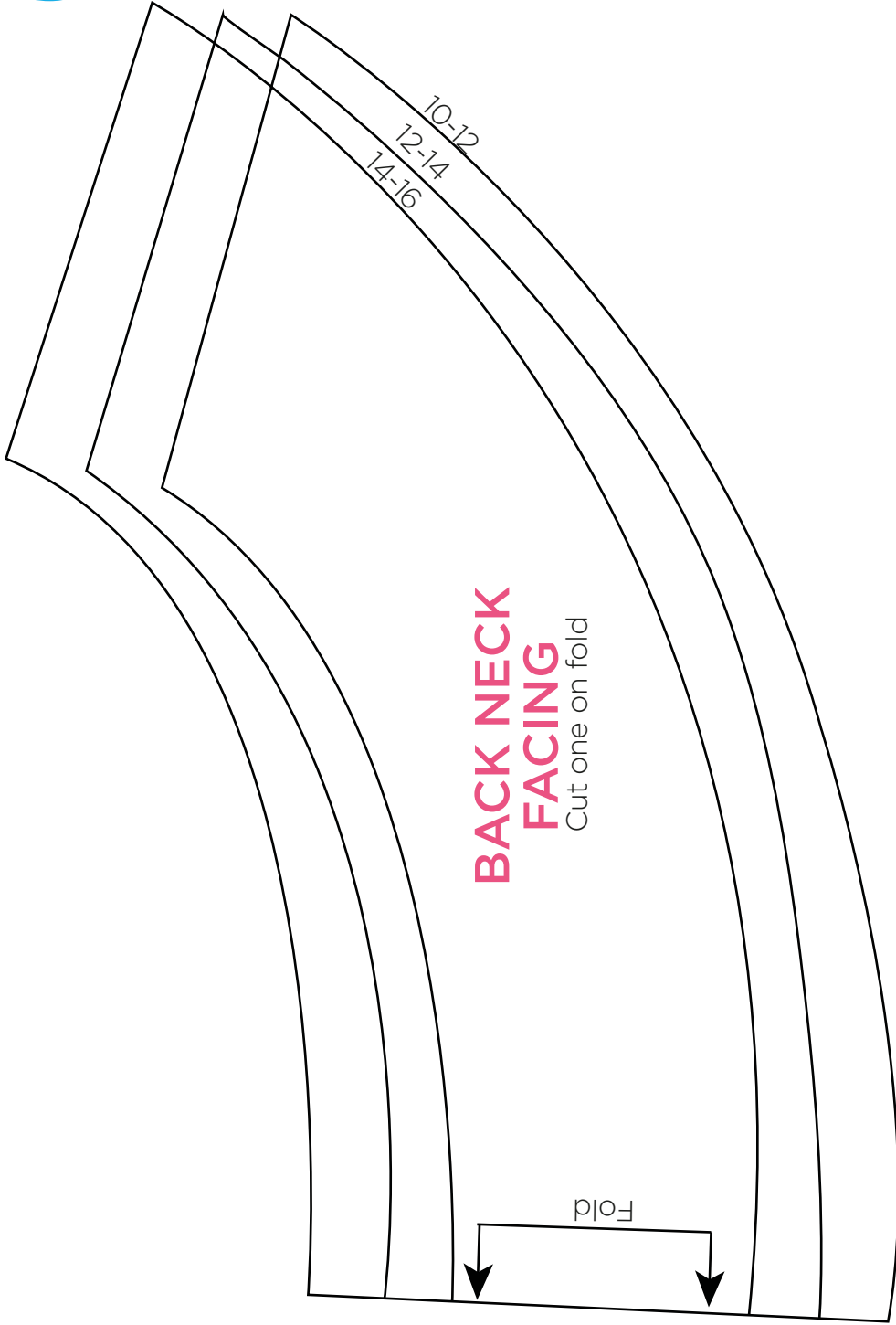

4

FRONT NECK FACING

Cut one on fold

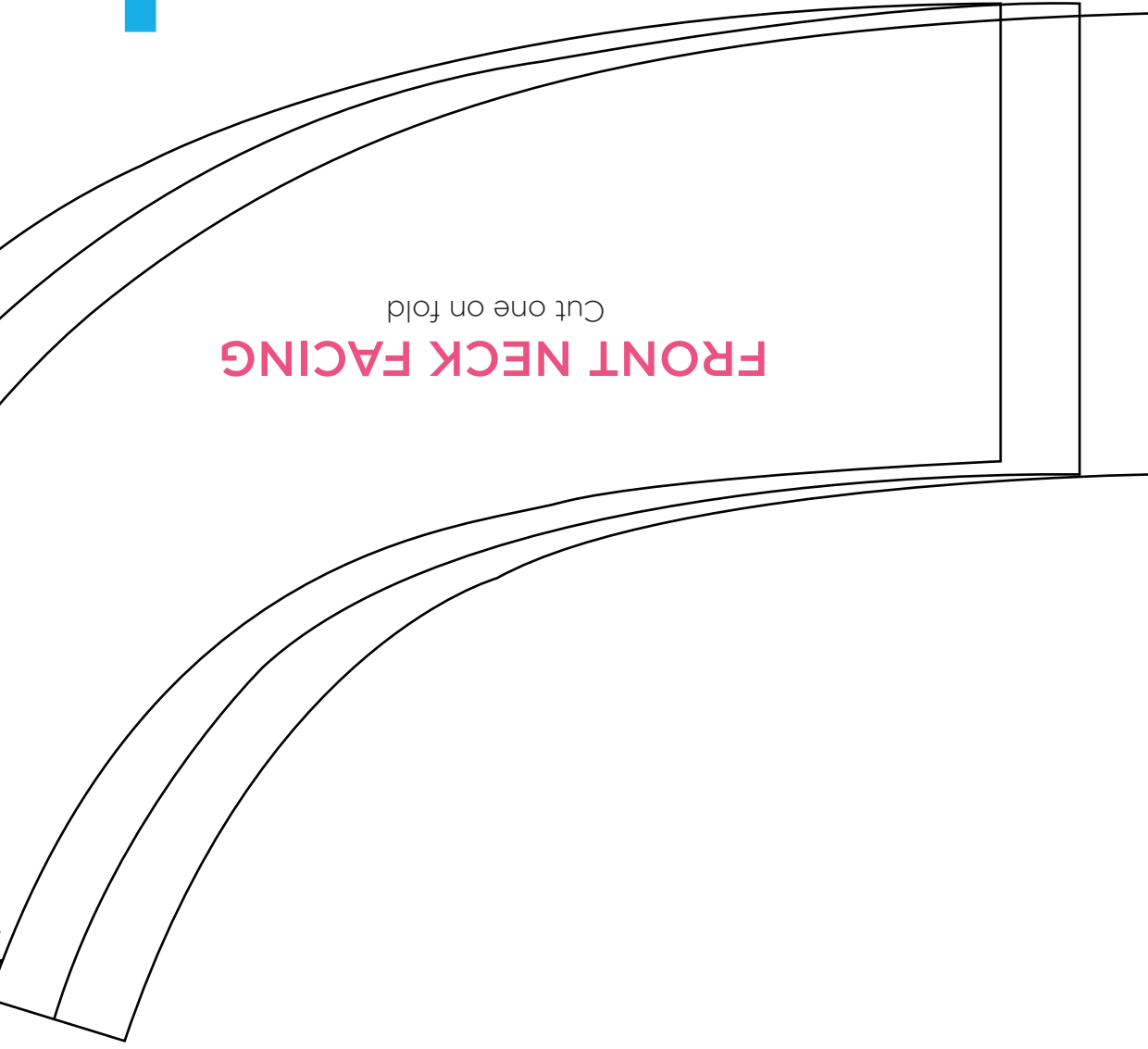

5

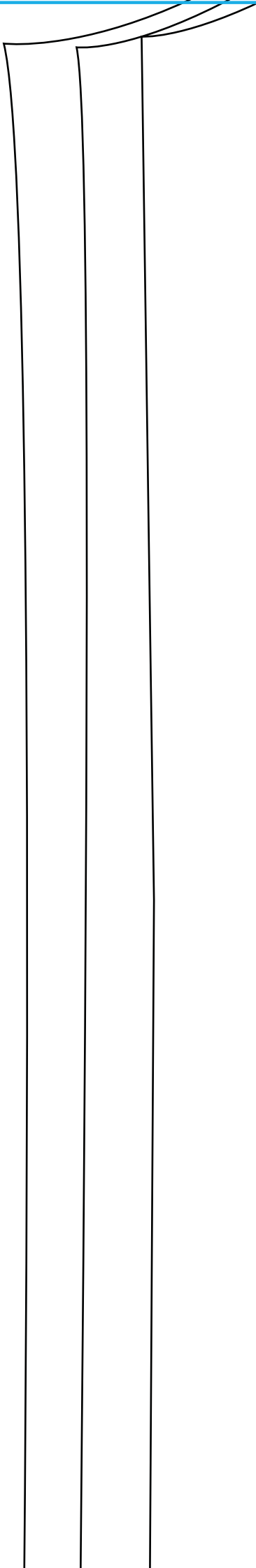

6

FRONT
Cut one on fold

7

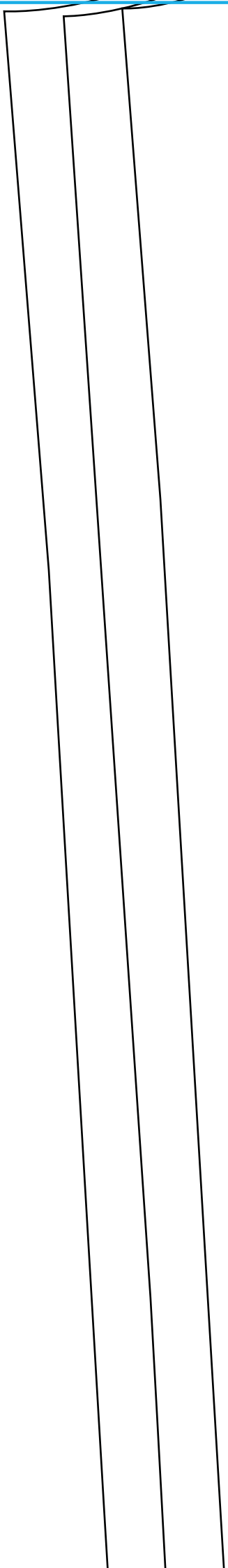

8



9

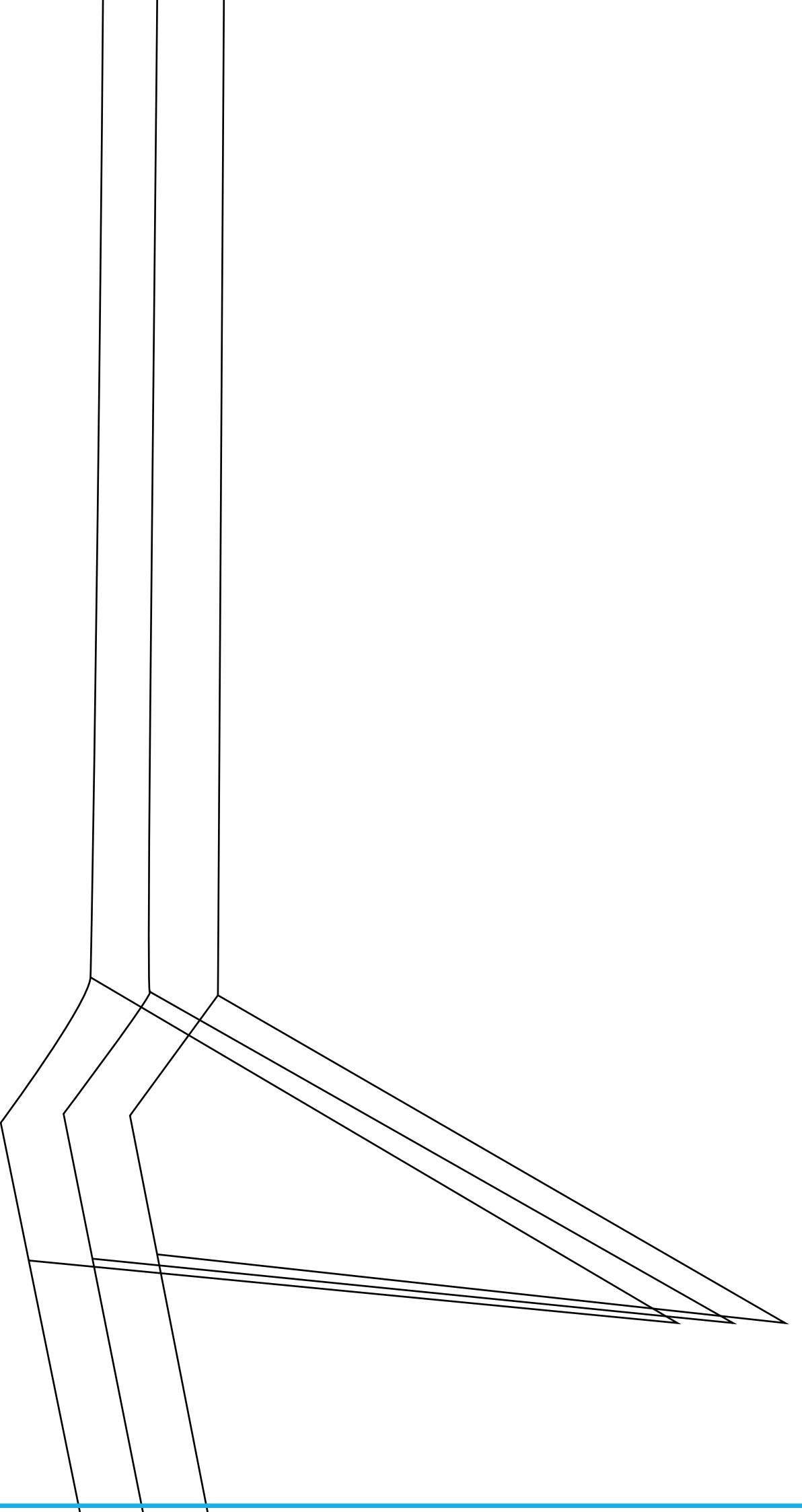

10

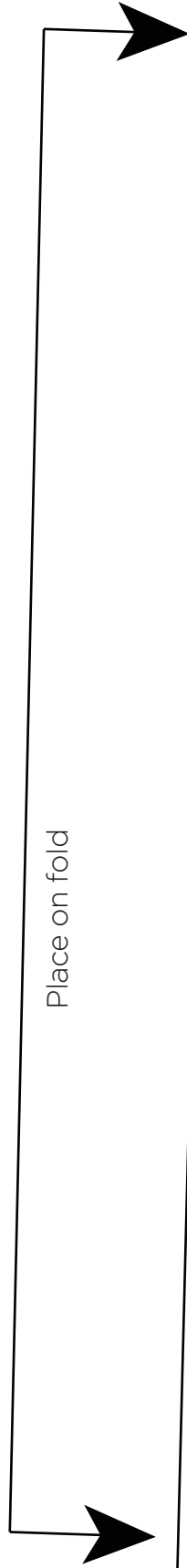

11

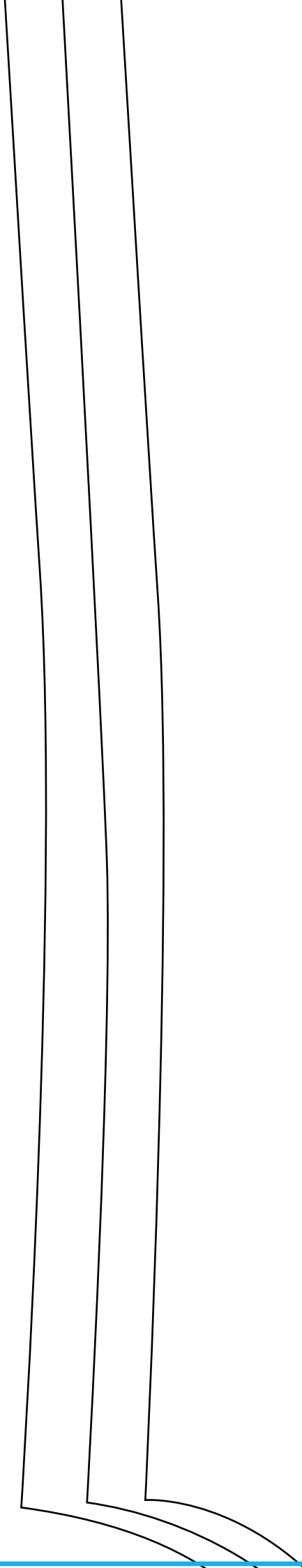

BACK
Cut one on fold

12



Place on fold

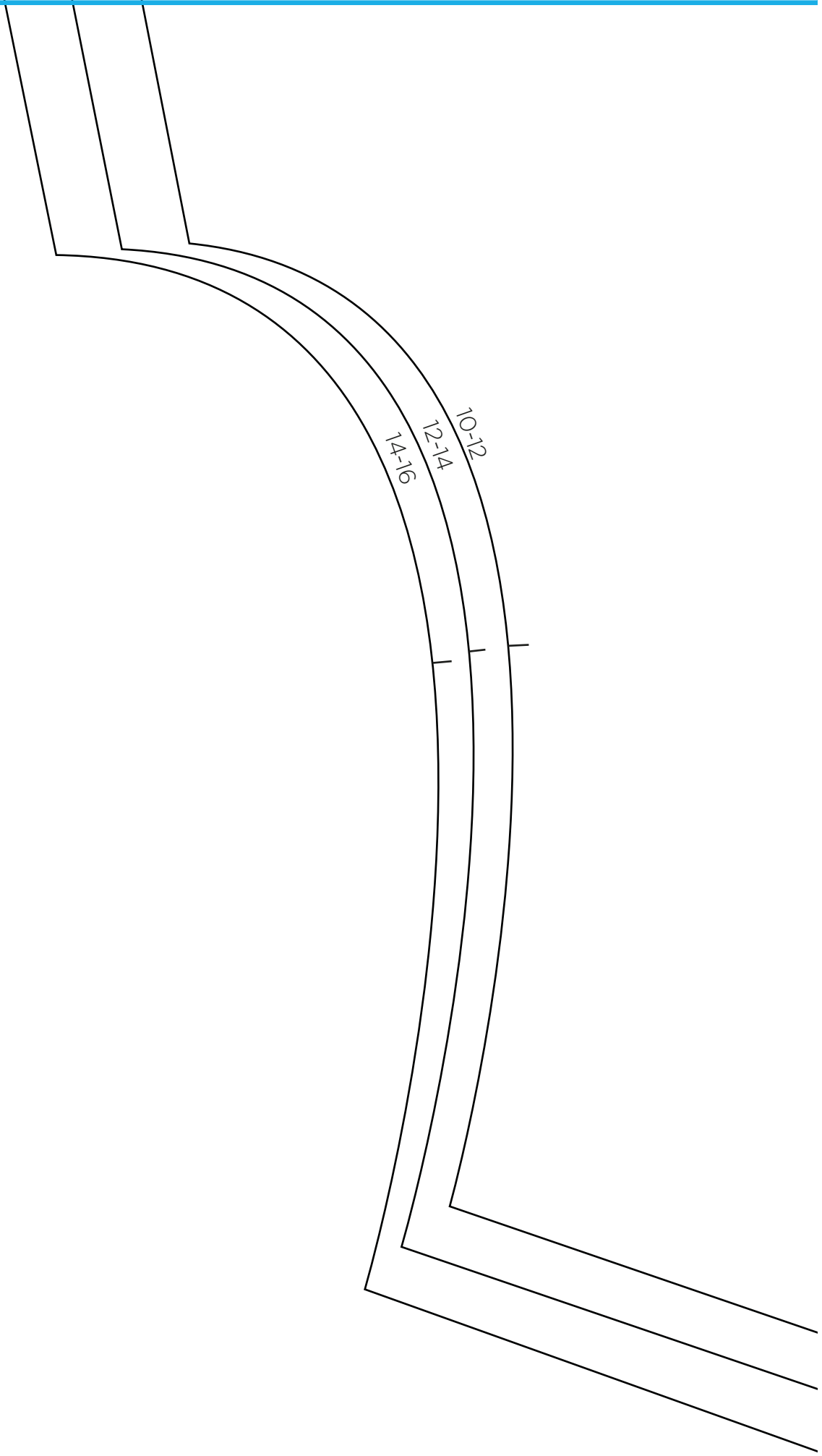

14

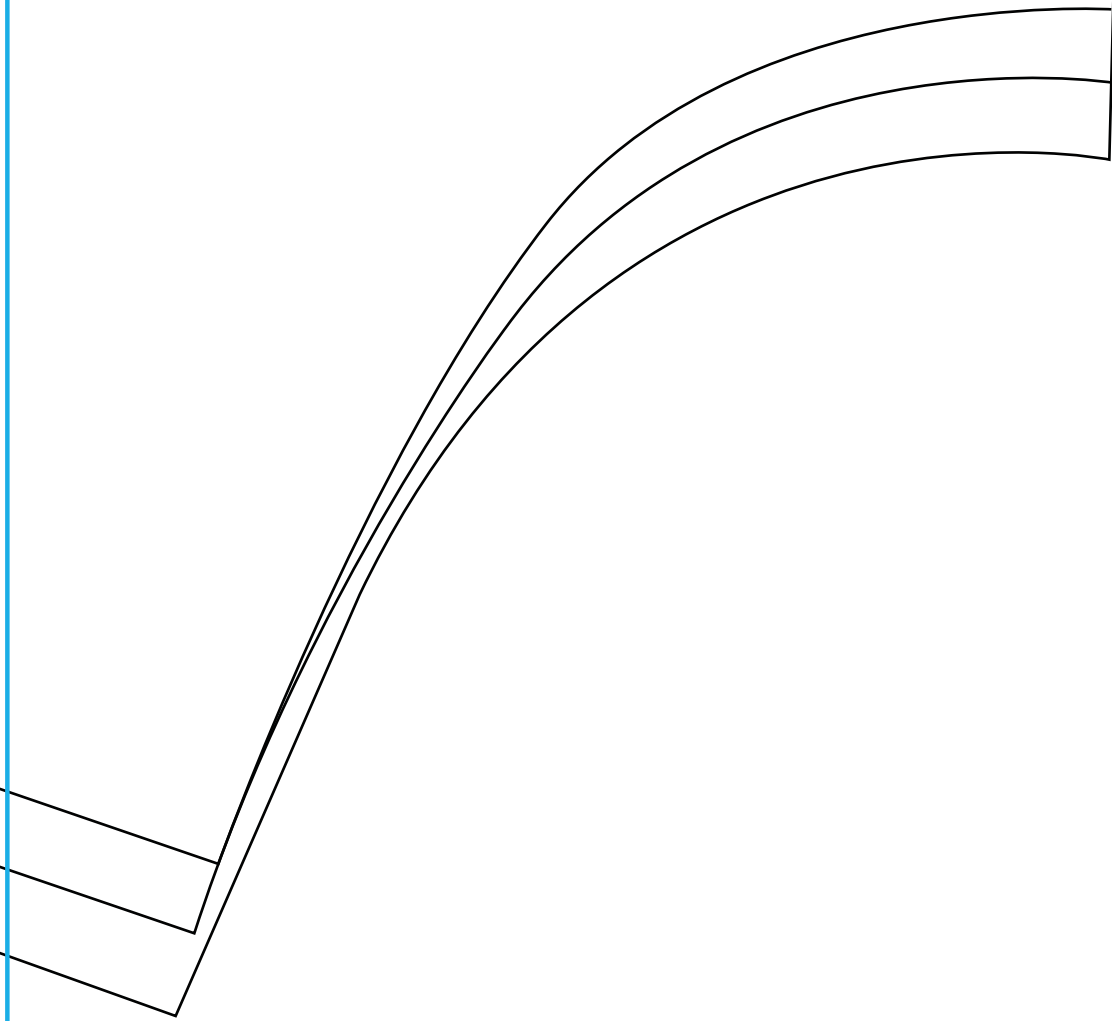

15

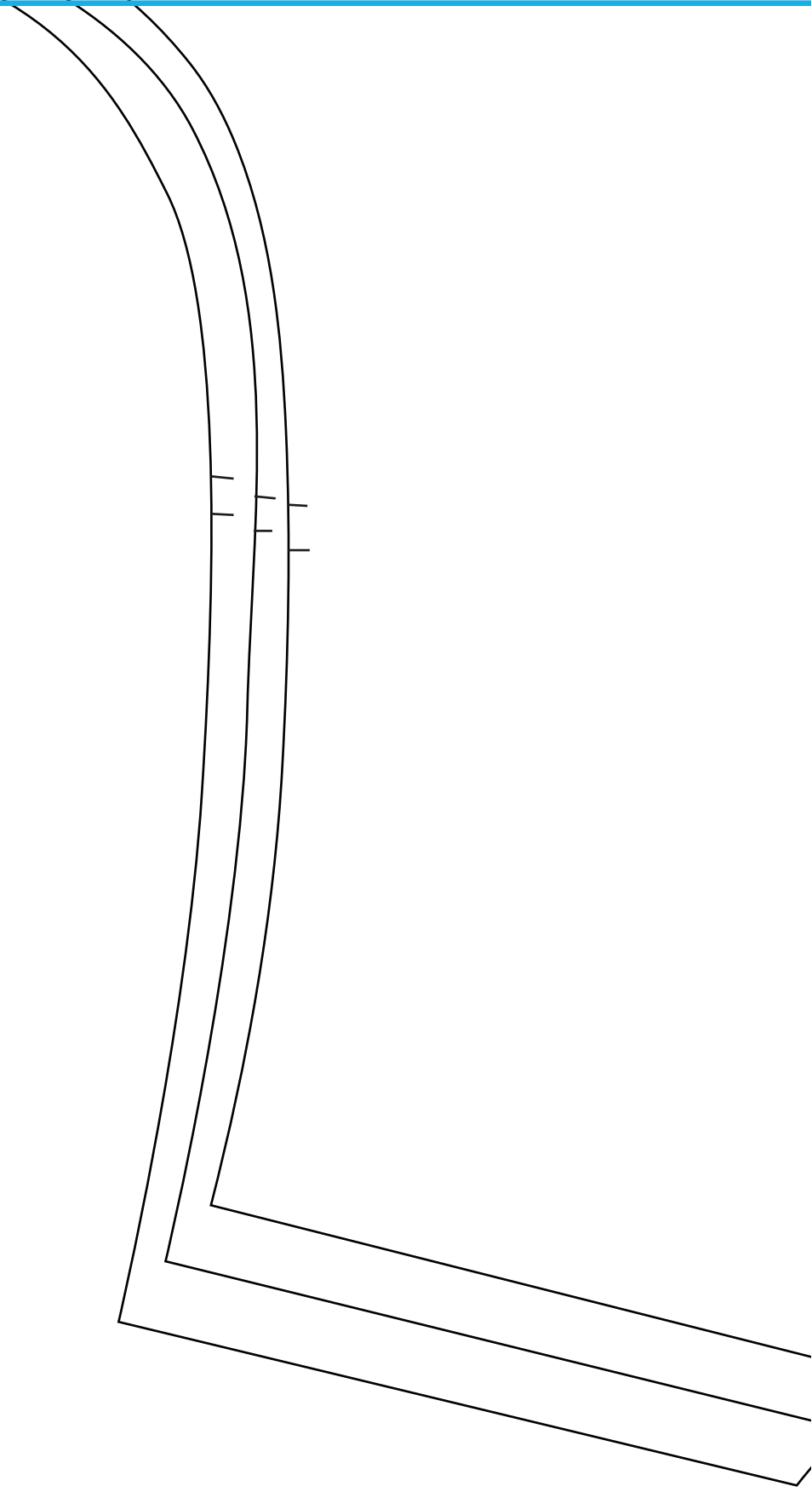

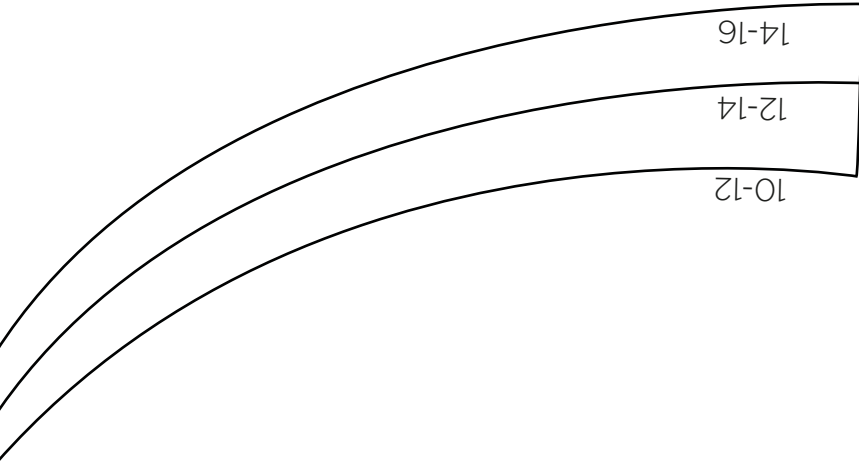

17

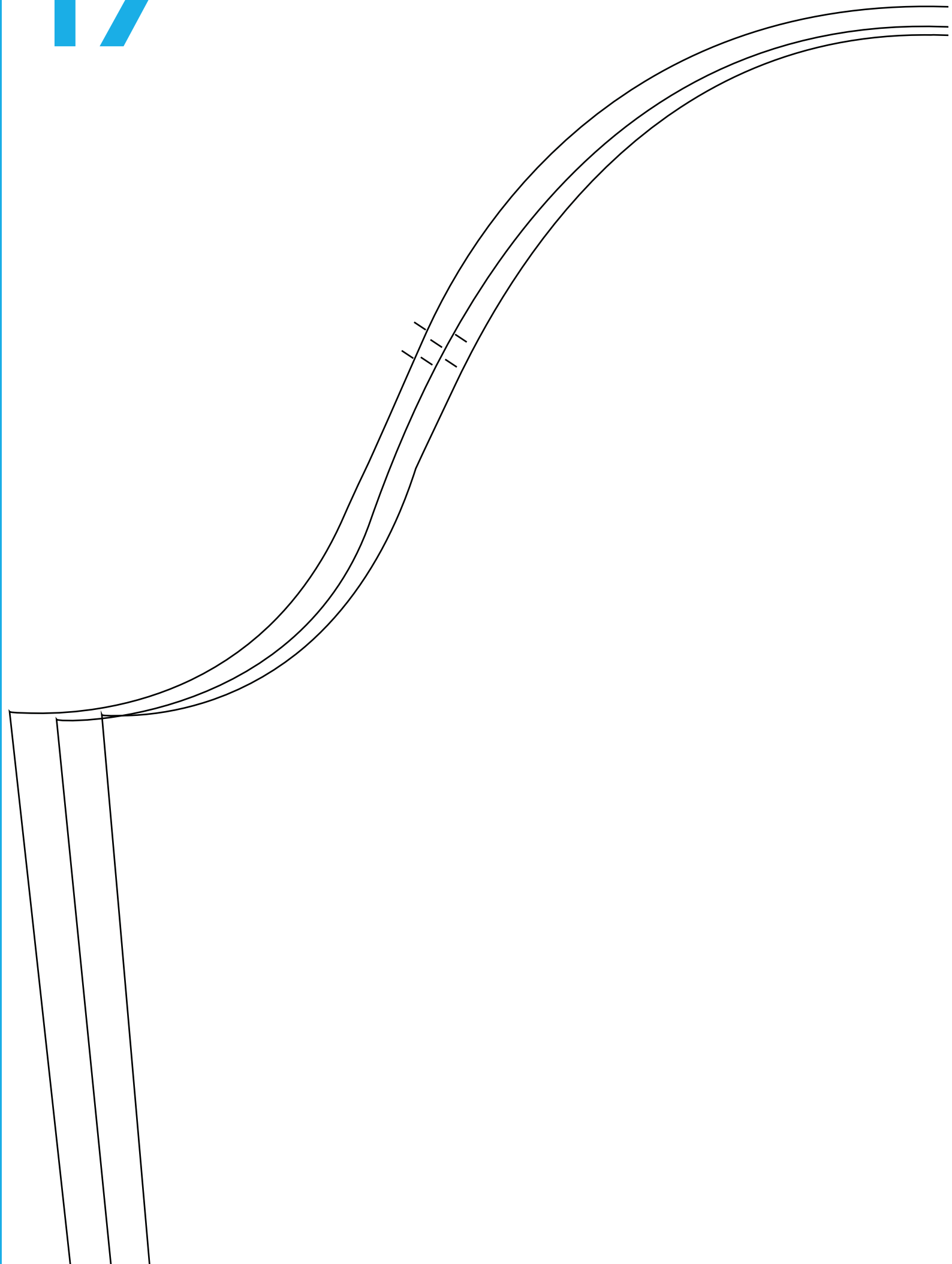

18



SLEEVE
Cut one pair

19

10-12

12-14

14-16



20

